



























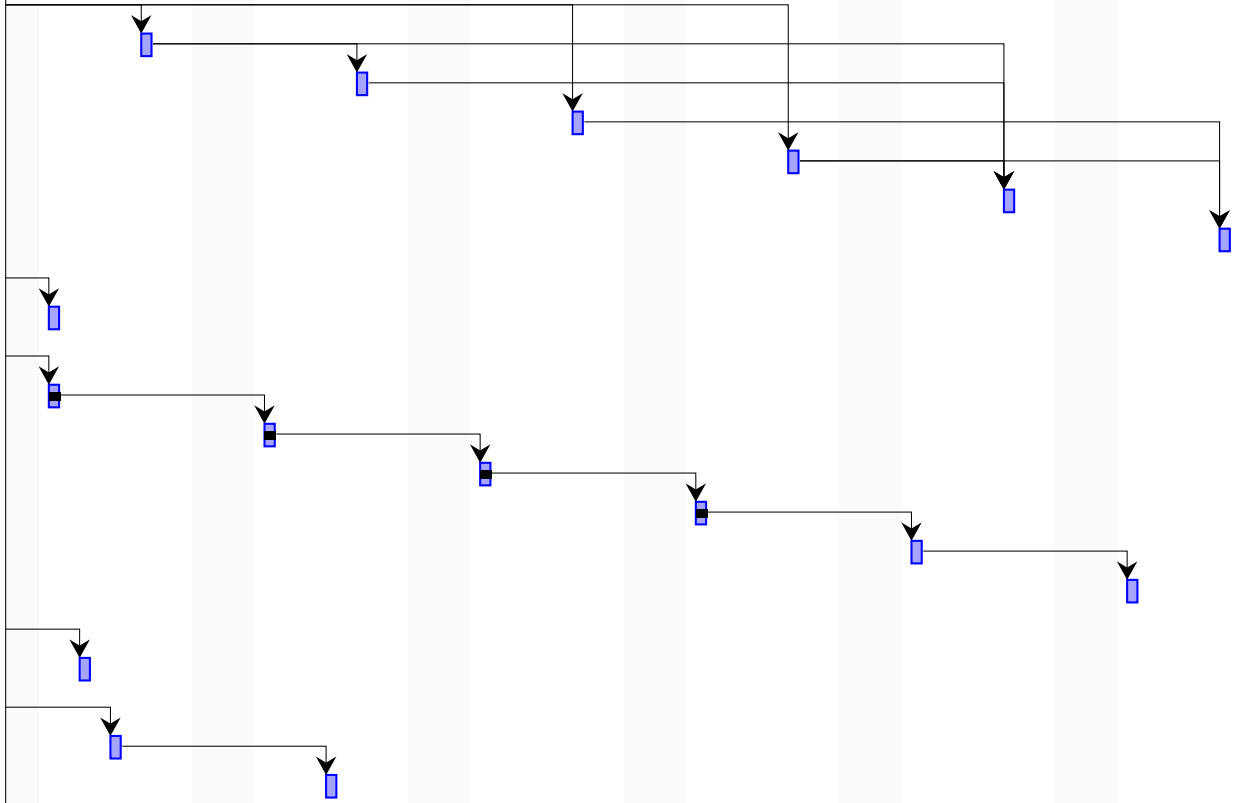
	Name	Duration
1		UNIT 17 (P4) Produce a Project Specification	1 day?
2		UNIT 17 (P5) Produce a Project Plan relating to ICT	1 day?
3		UNIT 17 (P6) Follow A Project Plan relating to ICT	1 day?
4		UNIT 17 (P7) Carry out a review of the Project Plan	1 day?
5		UNIT 17 (M2) Assess impact of risks on a Project Plan	1 day?
6		UNIT 17 (M3) Monitor the Project Plan Adapting as Circumstances Change	1 day?
7		UNIT 17 (D1) Demonstrate Effective Communication with Stakeholders	1 day?
8		UNIT 17 (D2) Evaluate Effectiveness of Tools	1 day?
9		UNIT 18 (M4) Implement an Automated Function	1 day?
10		UNIT 18 (D1) Discuss How Potential Errors In The Design and Construction of a Database can be Avoided	1 day?
11	 	UNIT 25 (P4) Perform Routine Housekeeping on a computer system	1 day?
12	 	UNIT 25 (P5) Use Monitoring Tools To Assess System Performance	1 day?
13	 	UNIT 25 (P6) Improve a System By Upgrading Hardware and Software	1 day?
14	 	UNIT 25 (M2) Recommend Suitable Hardware and Software Upgrades	1 day?
15	 	UNIT 25 (M3) Test Functionality of an Upgraded System	1 day?
16		UNIT 25 (D1) Evaluate Improvements To Computer Systems achieved Through Routine Housekeeping Procedures	1 day?
17		UNIT 25 (D2) Evaluate Performance Changes To Computer Systems After Hardware And Software Upgrades	1 day?
18		UNIT 29 (D1) Justify a Particular Installation Or Upgrade	1 day?
19		UNIT 29 (D2) Evaluate The Risks Involved In The Installation or Upgrade of Software and Explain How The Risks Could Be Minimised	1 day?
20		UNIT 30 (M2) Justify The Software, Tools, File Format, Image Resolution And Colour Depth Used For Creating Graphic Images	1 day?
21		UNIT 30 (D1) Evaluate The Impact of Evolving Output Mediums on The Design And Creation of Graphic Images	1 day?
22		UNIT 30 (D2) Discuss The Impact That File Format, Compression Techniques, Image Resolution and Colour Depth Have On File Size and Image Quality	1 day?
23		CISCO CCNA Semester 3	1 day?
24		CISCO CCNA Semester 4	60 days?

7 Apr 14					14 Apr 14					21 Apr 14					28 Apr 14					5 May 14					12 May 14					19 May 14					26 May 14					2 Jun 14					9 Jun 14																																
S	M	T	W	T	F	S	S	M	T	W	T	F	S	S	M	T	W	T	F	S	S	M	T	W	T	F	S	S	M	T	W	T	F	S	S	M	T	W	T	F	S	S	M	T	W	T	F	S	S	M	T	W	T	F	S	S	M	T	W	T	F	S	S	M	T	W	T	F	S	S	M	T	W	T	F	S	S



			16 Jun 14				23 Jun 14				30 Jun 14				7 Jul 14				14 Jul 14				21 Jul 14														
F	S	S	M	T	W	T	F	S	S	M	T	W	T	F	S	S	M	T	W	T	F	S	S	M	T	W	T	F	S	S	M	T	W	T			
																															</						